



The Essence

“La natura
ci dona il legno.
Per ringraziarla,
noi artigiani
esaltiamo l’unicità
di ogni tronco.”

Giuseppe Mardegan

Fondatore di Mardegan legno



Radici salde, sguardo rivolto al futuro

Mardegan Legno è un'azienda solida e in continua evoluzione. Nata dalla passione e dal talento di Giuseppe Mardegan, ha sede nel cuore dei boschi ungheresi, dove cresce e matura il pregiato rovere di Slavonia.



The mark of
responsible forestry



The mark of
responsible forestry

Deep roots, looking toward the future

Mardegan Legno is a sound business, that is evolving constantly. Born from the passion and talent of Giuseppe Mardegan, it is located in the heartland of the Hungarian forests, where the precious Slavonian oak grows and matures.



Superfici lavorate a mano

Mardegan Legno crea superfici in legno lavorate e finite a mano.

A partire dalla selezione dei tronchi, i professionisti di Mardegan Legno seguono tutte le fasi della lavorazione del legno, occupandosi personalmente di ogni passaggio: dalla segazione alla consegna del prodotto finito.

Hand-finished surfaces

Mardegan Legno creates wooden surfaces that are processed and finished by hand.

Beginning with the selection of the trunks, Mardegan Legno professionals follow every stage of the production process, monitoring each step: from the sawing to the delivery of the finished product.

Talenti e ricerca

Oggi l'azienda conta una squadra di più di 90 collaboratori, specializzati nella realizzazione di 13 lavorazioni di superficie, di cui ben 10 completamente artigianali e più di 140 colori fatti a mano. Un'offerta ricca ed esclusiva di superfici d'autore.

Talents and research

Today the company counts a team of more than 90 collaborators specialised in the creation of 13 surfaces finishes, 10 of which completely made by skilled artisans, and propose more than 140 colours made by hand. A rich exclusive series of designed surfaces.





Un alleato per i tuoi progetti

Mardegan Legno ti sostiene nella realizzazione dei progetti tuoi o dei tuoi clienti, mettendo a tua disposizione il supporto della rete agenti e gli strumenti progettati dall'ufficio marketing.

Fissa un appuntamento con il referente Mardegan Legno più vicino, scrivendo a italia@mardeganlegno.com.

An ally for your projects

Mardegan Legno can support you in the realization of your projects and the projects of your clients, providing the know-how of the agent network as well as all designed marketing tools.

Make an appointment with the Mardegan Legno agent nearest you by writing to international@mardeganlegno.com

Materia, ricerca, ispirazione

Nel lavoro di ricerca di Giuseppe Mardegan, la passione per il legno si accompagna alla libertà di ricerca e di ispirazione.

Nascono così le superfici Mardegan Legno: 15 collezioni e 7 "Forme" esclusive tra cui scegliere.

Material, research, inspiration

Studies conducted by Giuseppe Mardegan are a combination of passion for wood and freedom based on research and inspiration. This is how Mardegan Legno surfaces come into being: 15 collections and 7 exclusive "Shapes" to choose from.





Le nostre scelte incise nel legno

La nostra storia si compie nelle scelte importanti, le sole che avremmo potuto definire nostre e che imparerete a riconoscere toccando una qualsiasi delle superfici Mardegan Legno. Perché ogni scelta, quando è sentita, lascia le sue tracce: sul legno più profondamente che altrove.

Our choices engraved in the wood

Our history is fulfilled in important choices, the only ones that we could have defined as ours and that you will learn to recognize by touching any of the Mardegan Legno surfaces. Because every choice, when it is felt, leaves its traces: on the wood more deeply than elsewhere.

15 COLLEZIONI
15 COLLECTIONS

144 COLORAZIONI
144 COLOURS

13 LAVORAZIONI
13 FINISHES

7 FORME
7 SHAPES

3714

POSSIBILITÀ

POSSIBILITIES

Aspetti tecnici della materia

Mardegan Legno significa sicurezza, stabilità, solidità ma soprattutto nobiltà.

Ogni livello del legno è studiato per garantire al pavimento durezza e stabilità nel tempo.

La parte più pregiata della sua superficie varia da 4 mm fino ad arrivare a 7,2 mm di altezza nella versione "segato", la sua massima eccellenza.

Il miglior Rovere, Slavonia

L'anima dell'azienda è nel cuore dei boschi, luogo in cui crescono gli alberi, essenze nobili con più di cento anni di storia.

Tra le nostre selezioni utilizziamo anche il rovere di Slavonia, il miglior legno europeo, sulla cui esclusività costruiamo il senso del nostro lavoro.

TAVOLA SEGATO 3 STRATI



7,2
mm

STRATO
NOBILE



Disponibile in
22 e 17 mm

ALTEZZE DEGLI STRATI

	Strato nobile	7,2 mm	7,2 mm
	Strato intermedio Rovere o Abete	5,5 mm	10 mm
	Strato nobile inferiore	4,3 mm	4,8 mm
Totale		17 mm	22 mm

LUNGHEZZE E LARGHEZZE DISPONIBILI

Tavola Segato 3 strati 17 mm

Larghezze miste	Lunghezze miste
140/180/220 mm	da 1530 a 2730 mm

Tavola Segato 3 strati 22 mm

Larghezze miste	Lunghezze miste
180/250/300 mm	da 1530 a 3030 mm

STRATO NOBILE DISPONIBILE IN



TAVOLA SEGATO 2 STRATI

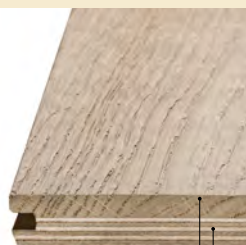

7,2
mm

STRATO
NOBILE



Disponibile in
16 mm

ALTEZZE DEGLI STRATI

	Strato nobile	7,2 mm
	Strato inferiore in multistrato di betulla	8,8 mm
Totale		16 mm

LUNGHEZZE E LARGHEZZE DISPONIBILI

Larghezze miste	Lunghezze miste
120/140/180 mm	da 930 a 2430 mm

STRATO NOBILE DISPONIBILE IN



TAVOLA 3 STRATI



5,2
mm

STRATO
NOBILE



Disponibile in
20 mm

ALTEZZE DEGLI STRATI

	Strato nobile	5,2 mm
	Strato intermedio Abete	10 mm
	Strato nobile inferiore	4,8 mm
Totale		20 mm

LUNGHEZZE E LARGHEZZE DISPONIBILI

Tavola Segato 3 strati 20 mm

Larghezze miste	Lunghezze miste
180/250/300 mm	da 1530 a 3030 mm



Larghezze miste	Lunghezze miste
340/400/500 mm	da 1530 a 3030 mm

STRATO NOBILE DISPONIBILE IN



TAVOLA 3 STRATI

5,2 mm
STRATO NOBILE

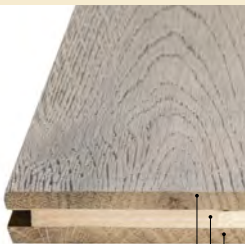

Disponibile in
15 mm

ALTEZZE DEGLI STRATI

	Strato nobile	5,2 mm
	Strato intermedio Rovere o Abete	5,5 mm
	Strato nobile inferiore	4,3 mm
Totale		15 mm

LUNGHEZZE E LARGHEZZE DISPONIBILI

Larghezze miste	Lunghezze miste
140/180/220 mm	da 1530 a 2730 mm



INDICATO PER
RISCALDAMENTO
A PAVIMENTO

STRATO NOBILE DISPONIBILE IN



TAVOLA 2 STRATI

5,2 mm
STRATO NOBILE



Disponibile in
14 mm

ALTEZZE DEGLI STRATI

	Strato nobile	5,2 mm
	Strato inferiore in multistrato di Betulla	8,8 mm
Totale		14 mm

LUNGHEZZE E LARGHEZZE DISPONIBILI

Larghezze miste	Lunghezze miste
120/140/180 mm	da 930 a 2430 mm



INDICATO PER
RISCALDAMENTO
A PAVIMENTO

STRATO NOBILE DISPONIBILE IN



TAVOLA 2 STRATI

4,2 mm
STRATO NOBILE



Disponibile in
11 mm

ALTEZZE DEGLI STRATI

	Strato nobile	4,2 mm
	Strato inferiore in multistrato di Betulla	6,8 mm
Totale		11 mm

LUNGHEZZE E LARGHEZZE DISPONIBILI

Larghezze miste	Lunghezze miste
90/140/180 mm	da 930 a 2130 mm



INDICATO PER
RISCALDAMENTO
A PAVIMENTO

STRATO NOBILE DISPONIBILE IN



Lunghezze e larghezze miste

Per amore della natura, suggeriamo la scelta di tavole di dimensioni diverse, come il taglio le ha generate.

Senza sprechi.

Perché un pavimento con larghezze e lunghezze miste è una scelta responsabile, ma è anche il modo migliore per dare movimento e profondità a una superficie.

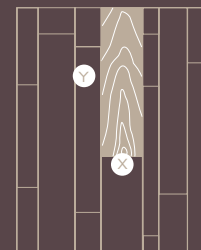



Le selezioni

Durante il processo produttivo avviene una divisione minuziosa delle lamelle in tre principali tipologie chiamate "selezioni".

L'occhio allenato dei nostri esperti permette una precisa classificazione delle singole tavole sulla base del disegno che la natura ha operato.

Su ogni tavola osserviamo la presenza di diversi tratti e segni. Il passaggio del tempo, l'umidità e la temperatura lasciano incise nel legno impronte sempre diverse, simbolo che niente è definito e che la bellezza della natura risiede nella sua imprevedibilità e imperfezione.

The selections

During the production process, the lamellas are carefully divided into three main types called "selections".

The trained eyes of our experts make it possible to reach a precise classification of the individual boards, based on the design that nature created. We observe the presence of different marks and signs on each board. Over time, humidity and temperature also leave a variety of signs, demonstrating that nothing is definitive and that the beauty of nature resides in its unpredictability and imperfection.

Selezione A

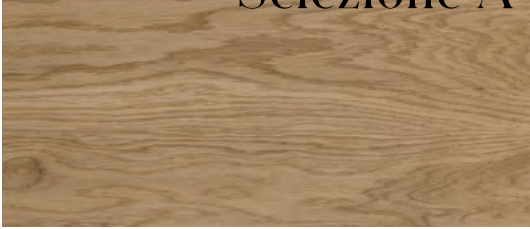

La nostra selezione A è costituita dalle parti più regolari del legno, caratterizzata da una fibratura dritta, obliqua e a fiamma tornante. Osservando questa superficie si può riscontrare la presenza di piccoli nodini o gruppi di nodini dal diametro non superiore a 10 mm. Le differenze cromatiche percepibili sono dovute alle caratteristiche naturali del legno stesso.

Our selection A consists of the most homogeneous parts of the wood, characterised by a straight or oblique fibre and hairpin flame pattern or veins. When observing the surface small knots or clusters of knots can be found, but no larger than 10 mm. The noticeable chromatic differences are due to the natural characteristics of the wood itself.

Selezione B



La selezione B è costituita dalle parti più ricche del legno, caratterizzata da una fibratura mista, a fiamma tornante o ritorta. È possibile notare la presenza di alcuni nodi o gruppi di nodi sani o attentamente stuccati, dal diametro non superiore a 40 mm e, alcune volte, la presenza di piccole crepe o piccoli fori. Le differenze cromatiche percepibili sono dovute alle caratteristiche naturali e spontanee del legno stesso.

Selection B consists of the richer parts of the wood, characterised by a mixed fibre, with hairpin or twisted flame patterns or veins. It may also be possible to note some knots or clusters of knots, either healthy or carefully filled, of diameters no larger than 40 mm and, sometimes, the presence of small cracks or small holes. The noticeable chromatic differences are due to the natural characteristics of the wood itself.

Selezione Unica



La selezione unica è costituita da una ricchezza di materia e da una struttura del legno sempre variabile e per sua natura imperfetta. È caratterizzata da una fibratura mista, rigata, fiammata e ritorta, e dalla presenza di crepe aperte o stuccate, di piccoli fori e di alcuni nodi sani o gruppi di nodi dal diametro anche superiore a 40 mm. Sono inoltre percepibili delle differenze cromatiche, simbolo delle caratteristiche naturali e spontanee del legno stesso.

The unica selection consists of precious, high quality wood, the structure of which is always variable and imperfect by nature. It is characterised by a mixed fibre, lined, flamed, and twisted, and by the presence of open or filled cracks, small holes, and some healthy knots or clusters of knots with a diameter that sometimes exceeds 40mm. Chromatic differences can also be found, indicating the natural and spontaneous characteristics of the wood itself.



Lavorazioni di superficie

Abbiamo scelto di dedicare ai nostri pavimenti tutta la nostra sapienza artigiana, per far emergere dalla ricchezza del legno il suo volto più intimo. Piallati a mano, spazzolati, segati, i pavimenti Mardegan Legno sono unici perché sono il risultato della naturalità della materia con cui sono fatti e del lavoro artigianale che ne è alla base.

Working surfaces

We are proud to realize our surfaces with all our artisanal skills; to enhance the intimate beauty of the natural essence of the wood. The uniqueness of our working surfaces starting from the brushed to the hand planed and sawn rely on the power of the natural essence of the wood itself highlighted from the precious hand made work

Scavato



Dedicata in via esclusiva alla collezione Palatino, questa lavorazione ricrea l'atmosfera unica delle antiche dimore nobiliari. Le incisioni profonde corrono leggere lungo la tavola e danno luce alla bellezza più intima del legno.

SCOPRI COME VIENE REALIZZATO:
SCANSIONA IL CODICE O USA L'INDIRIZZO
WWW.MRDG.IT/IT-HWDI-SCAVATO



Prelevigato



Levigatura eseguita a macchina per una superficie particolarmente liscia. Bisellatura sui 4 lati.

SCOPRI COME VIENE REALIZZATO:
SCANSIONA IL CODICE O USA L'INDIRIZZO
WWW.MRDG.IT/IT-HWDI-PRELEVIGATO



Spazzolato



Un pavimento spazzolato regala la sensazione di una superficie liscia e levigata. Una serie di spazzole rimuove una minima parte della superficie più tenera, valorizzando le fiammature e la struttura della materia. Bisellatura sui 4 lati.

SCOPRI COME VIENE REALIZZATO:
SCANSIONA IL CODICE O USA L'INDIRIZZO
WWW.MRDG.IT/IT-HWDI-SPAZZOLATO



Segato



Rievocazione del processo più antico di segazione del legno su lamelle da 7,2 mm. La lama lascia sulla superficie i suoi segni, poi smussati con levigatura a mano. Bisellatura sui 4 lati.

SCOPRI COME VIENE REALIZZATO:
SCANSIONA IL CODICE O USA L'INDIRIZZO
WWW.MRDG.IT/IT-HWDI-SEGATO



Piallato Anticato



È la lavorazione manuale più complessa, unione della tecnica di piallatura e di un processo di anticatura, che riproduce lo stile di una volta e i segni del tempo. Bisellatura sui 4 lati.

SCOPRI COME VIENE REALIZZATO:
SCANSIONA IL CODICE O USA L'INDIRIZZO
WWW.MRDG.IT/IT-HWDI-PIALLATO-ANTICATO



Piallato a mano



Esperti artigiani piallano a mano ogni singola tavola, usando le tradizionali pialle a lama. La superficie prende vita e restituisce un gioco di volumi e movimento al pavimento. Bisellatura sui 4 lati.

SCOPRI COME VIENE REALIZZATO:
SCANSIONA IL CODICE O USA L'INDIRIZZO
WWW.MRDG.IT/IT-HWDI-PIALLATO



Stondato e piallato a mano



Alla lavorazione piallato a mano si aggiunge la stondatura manuale dei lati lunghi che dona al pavimento un piacevole effetto "onda".

SCOPRI COME VIENE REALIZZATO:
SCANSIONA IL CODICE O USA L'INDIRIZZO
WWW.MRDG.IT/IT-HWDI-STONDATO-PIALLATO



Consumato



Levigatura a mano per creare effetti di "avvallamento" lungo la tavola e nei suoi bordi. Esalta la tridimensionalità della superficie donando la sensazione di vissuto. Bisellatura sui 4 lati, arrotondata e irregolare.

SCOPRI COME VIENE REALIZZATO:
SCANSIONA IL CODICE O USA L'INDIRIZZO
WWW.MRDG.IT/IT-HWDI-CONSUMATO



Sabbiato



Lavorazione che, utilizzando un'altissima pressione, asporta dal legno la parte più tenera della fibra, creando una superficie dall'aspetto vissuto dal tempo. Bisellatura sui 4 lati.

SCOPRI COME VIENE REALIZZATO:
SCANSIONA IL CODICE O USA L'INDIRIZZO
WWW.MRDG.IT/IT-HWDI-SABBIATO



Piallato morbido e sabbiato



Piallatura molto tenue, realizzata solo su tavole di grandi dimensioni. Dopo la piallatura a mano, le tavole vengono impreziosite ed esaltate dalla sabbatura, che mette in evidenza e valorizza le fiammature e la struttura del legno. Bisellatura sui 4 lati.

SCOPRI COME VIENE REALIZZATO:
SCANSIONA IL CODICE O USA L'INDIRIZZO
WWW.MRDG.IT/IT-HWDI-PIALLATO-SABBIATO



Segato e sabbiato



Le lamelle segate da 7,2 mm di spessore vengono anche sabbiate. L'esaltazione delle venature nella lunghezza della tavola si accompagna ai segni della segazione creando l'esclusiva trama geometrica Mardegan Legno. Bisellatura sui 4 lati.

SCOPRI COME VIENE REALIZZATO:
SCANSIONA IL CODICE O USA L'INDIRIZZO
WWW.MRDG.IT/IT-HWDI-SEGATO-SABBIATO



Scolpito a mano



Esclusiva lavorazione manuale fatta dai maestri artigiani di Mardegan Legno con pialle dalla lama a scalpello. L'effetto è un suggestivo intreccio tra i segni degli intarsi e le fiammature delle singole tavole. Bisellatura sui 4 lati.

SCOPRI COME VIENE REALIZZATO:
SCANSIONA IL CODICE O USA L'INDIRIZZO
WWW.MRDG.IT/IT-HWDI-SCOLPITO



Stonato e sabbiato



L'effetto onda sul lato lungo delle tavole offre la sensazione di tridimensionalità alla superficie mentre la sabbatura esalta la naturalità delle venature.

SCOPRI COME VIENE REALIZZATO:
SCANSIONA IL CODICE O USA L'INDIRIZZO
WWW.MRDG.IT/IT-HWDI-STONATO-SABBIATO





VICTORIA SPAZZOLATO / BRUSHED

6
Lavorazioni
Surface finishes

Spazzolato / *Brushed*

Segato / *Sawn*

Sabbiato / *Sandblasted*

Stondato Sabbiato / *Rounded Sandblasted*

Piallato Morbido Sabbiato / *Soft Hand Planed Sandblasted*

Segato Sabbiato / *Sawn Sandblasted*

11
Colorazioni
Colors

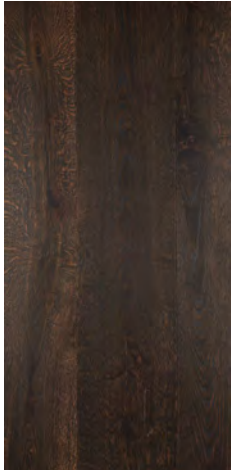

BRIXTON

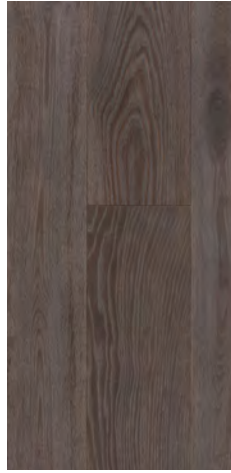

COVENT
GARDEN

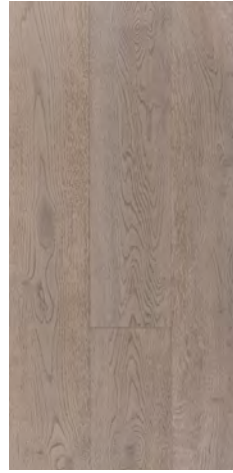

HARROW

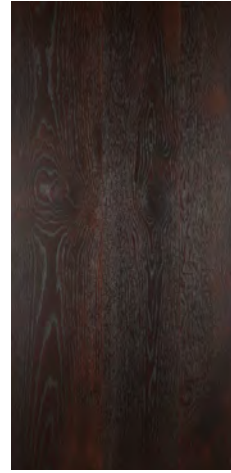

LONDON
BRIDGE

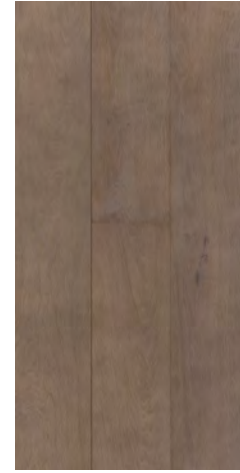

MOORGATE

PADDINGTON

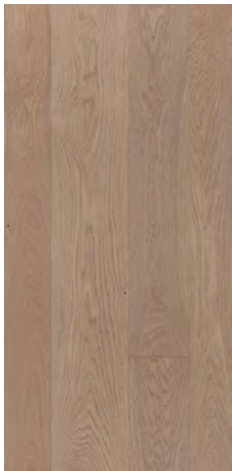

PICCADILLY
CIRCUS

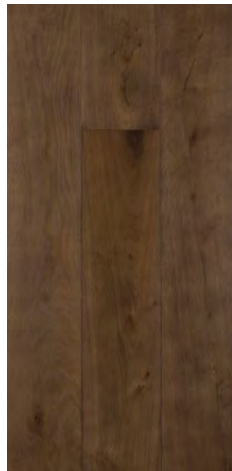

STRATFORD

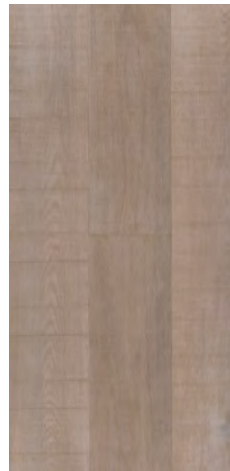

VICTORIA

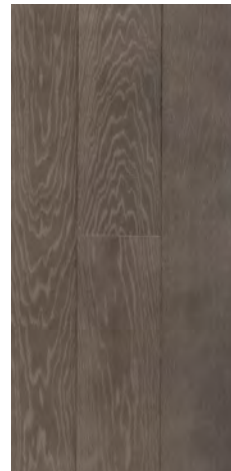

WESTMINSTER



WIMBLEDON



PARIS MON AMOUR



DÉFENSE SPAZZOLATO / BRUSHED

6 Lavorazioni Surface finishes

Spazzolato / Brushed

Segato / Sawn

Sabbiato / Sandblasted

Stondato Sabbiato / Rounded Sandblasted

Piallato Morbido Sabbiato / Soft Hand Planed Sandblasted

Segato Sabbiato / Sawn Sandblasted

11
Colorazioni
Colors

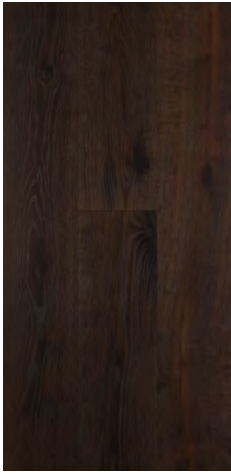

BASTILLE

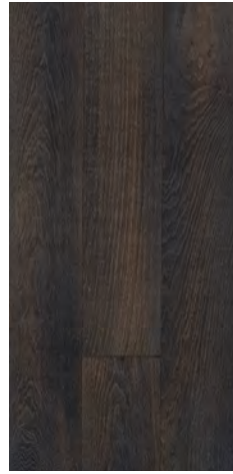

DÉFENSE

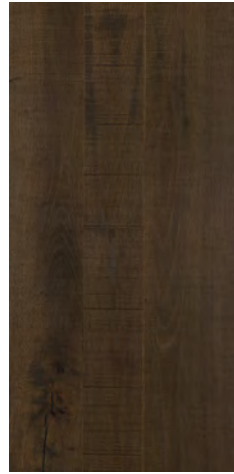

LE CHAT
NOIR

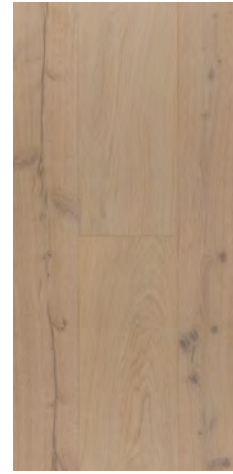

LES HALLES

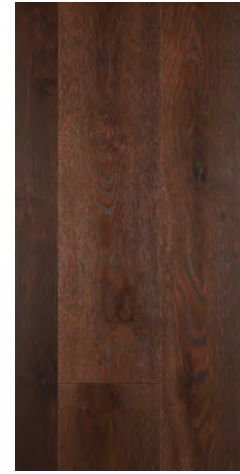

LE MARAIS

LOUVRE



MONTMARTRE

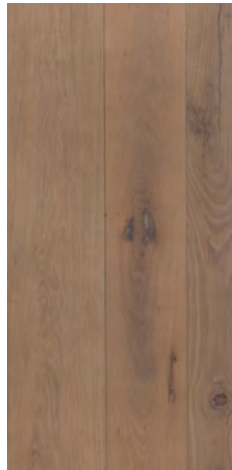

MOULIN
ROUGE

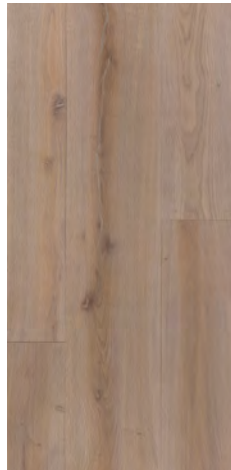

NOTRE
DAME

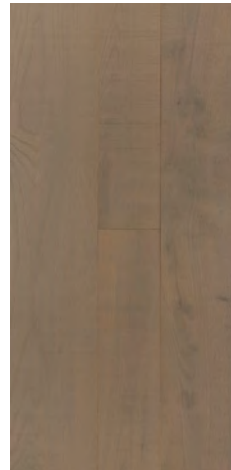

OPÉRA



TOUR
EIFFEL



LIVE IN NEW YORK



BROOKLYN SABBIAIO / SANDBLASTED

6 Lavorazioni Surface finishes

Spazzolato / *Brushed*

Segato / *Sawn*

Sabbiato / *Sandblasted*

Stondato Sabbiato / *Rounded Sandblasted*

Piallato Morbido Sabbiato / *Soft Hand Planed Sandblasted*

Segato Sabbiato / *Sawn Sandblasted*

11
Colorazioni
Colors

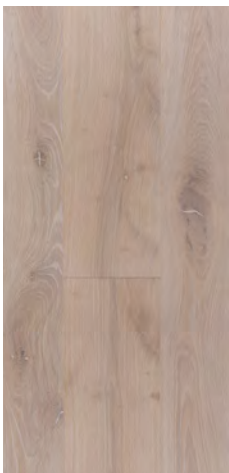

BROADWAY

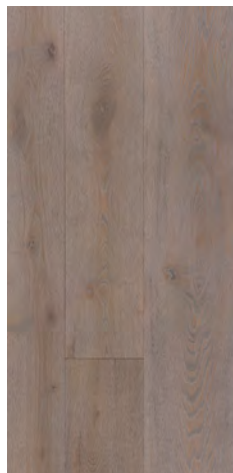

BROOKLYN

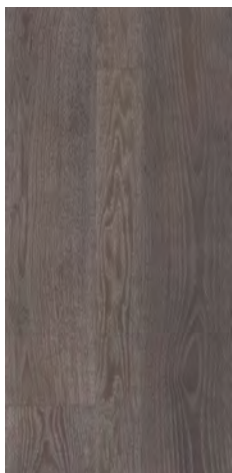

CENTRAL
PARK

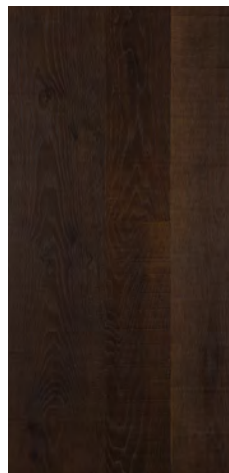

HARLEM

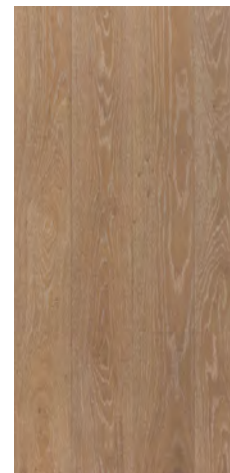

HUDSON

MANHATTAN

MARBLE
HILL

NEW
JERSEY

PARK
AVENUE

TIMES
SQUARE

WEST
SIDE

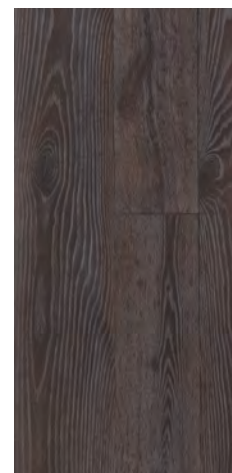
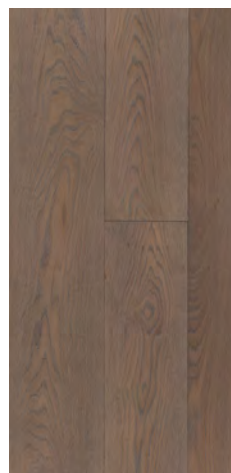
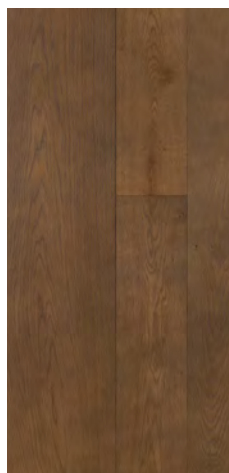
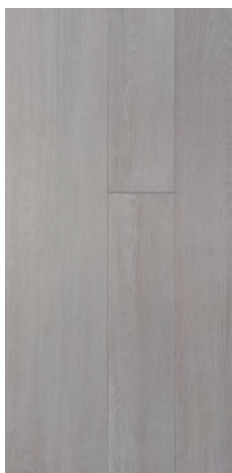



SABBIA SABBIAATO / SANDBLASTED

10
Lavorazioni
Surface finishes

Spazzolato / *Brushed*

Sabbiato / *Sandblasted*

Stonato Sabbiato / *Rounded Sandblasted*

Piallato Morbido Sabbiato / *Soft Hand Planed Sandblasted*

Segato Sabbiato / *Sawn Sandblasted*

Segato / *Sawn*

Piallato a Mano / *Hand Planed*

Stonato e Piallato a mano / *Rounded Hand Planed*

Scolpito a Mano / *Hand Sculptured*

Piallato Anticato / *Hand Planed Antiqued*

22

Colorazioni
Colors

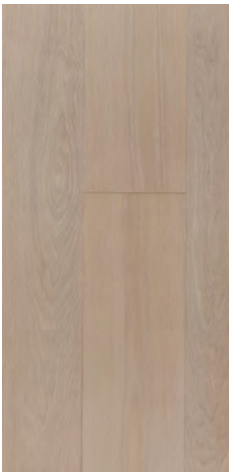

BIANCO
LUNA

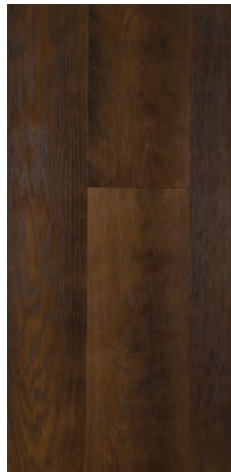

CARBONE

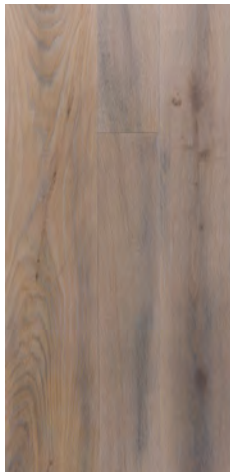

CIPRIA

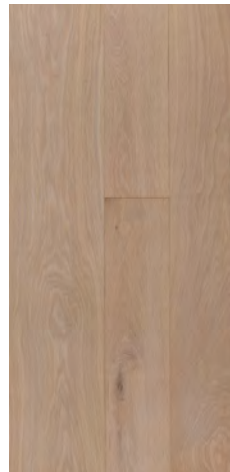

CREMA



CUMINO



CURCUMA

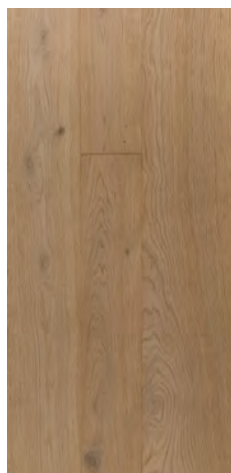

ESSENZA

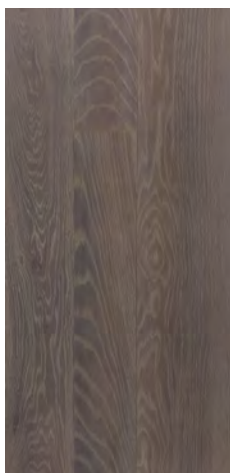

GHIACCIO

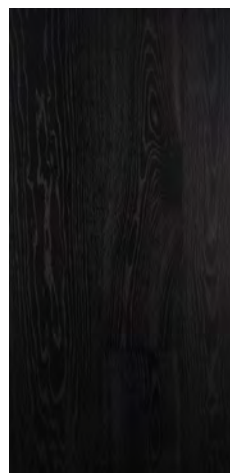

GRAFITE



GRIGIO
FERRO



GRIGIO
OLTREMARE

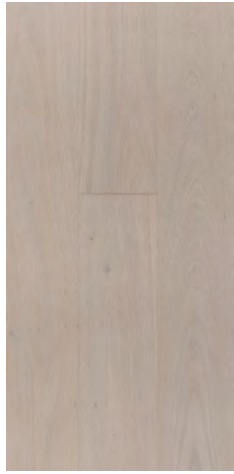

LATTE

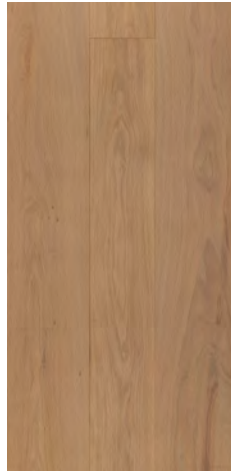

MALTO

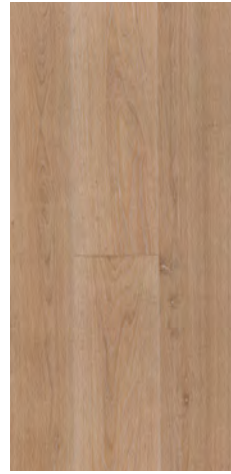

NEBBIA



PANNA



SABBIA

SENAPE



TORRONE

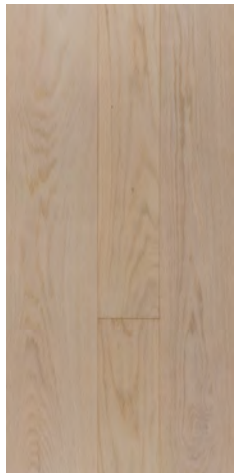

VARIEGATO



VECCHIO
CARTA

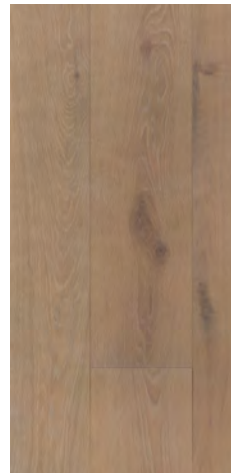

ZAFFERANO

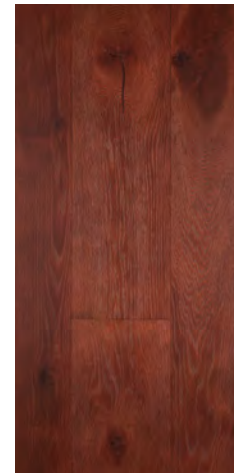

ZUCCHERO

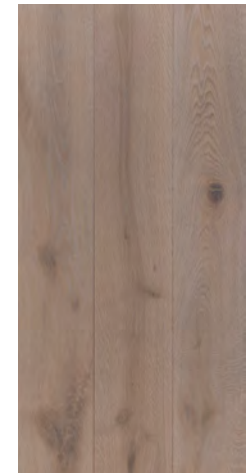



ORO PIALATO A MANO / HAND PLANED

11
Lavorazioni
Surface finishes

Spazzolato / *Brushed*

Pialato a Mano / *Hand Planed*

Stonato e Pialato a Mano / *Rounded Hand Planed*

Pialato Anticato / *Hand Planed Antiqued*

Scolpito a Mano / *Hand Sculpted*

Consumato / *Aged*

Segato / *Sawn*

Sabbiato / *Sandblasted*

Stonato Sabbiato / *Rounded Sandblasted*

Pialato Morbido Sabbiato / *Soft Hand Planed Sandblasted*

Segato Sabbiato / *Sawn Sandblasted*

22

Colorazioni
Colors

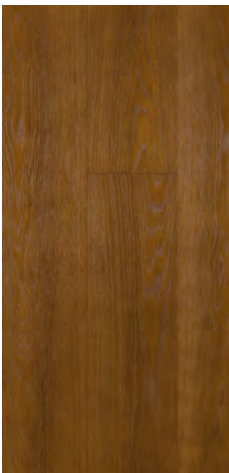

AVANA



BRANDY

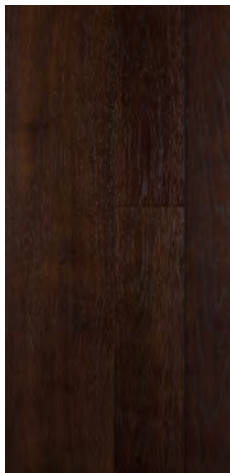

CAFFÈ

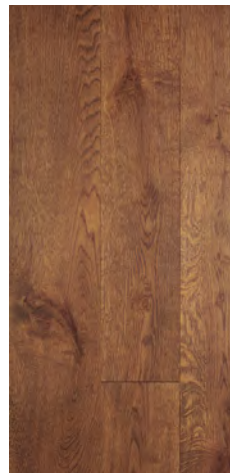

CANNELLA



CARMELLO

CENERE

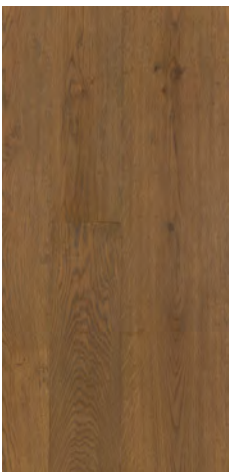

COGNAC

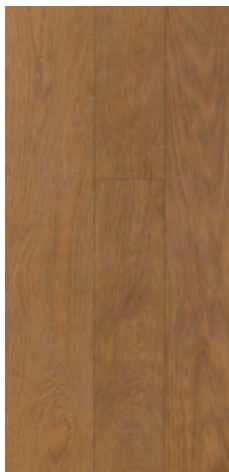

CUOIO

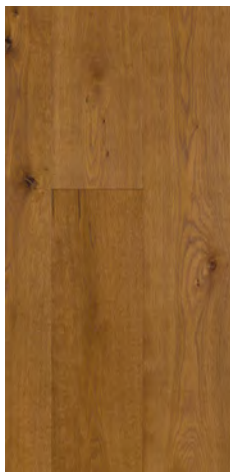

GRIGIO
ARTICO

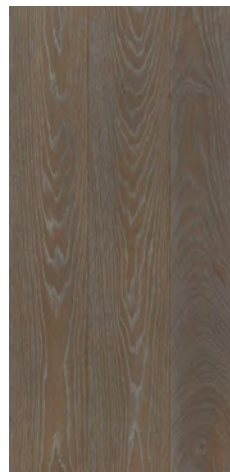

GRIGIO
CEMENTO



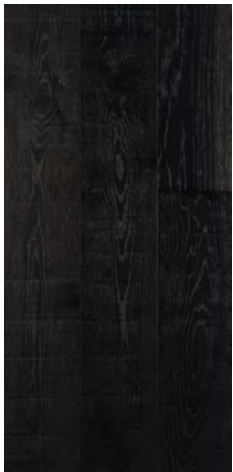

GRIGIO
FUMO

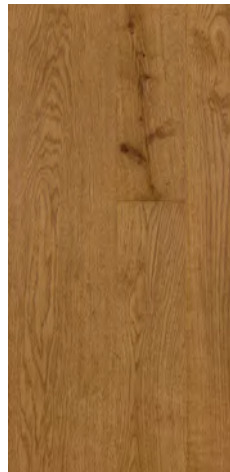

MIELE
CHIARO



MIELE
SCURO

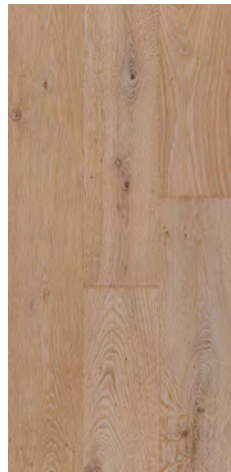

NEVE



NOCCIOLA

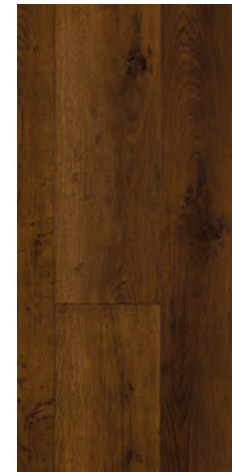

NOCE

ORO



ROVERE
ANTICO

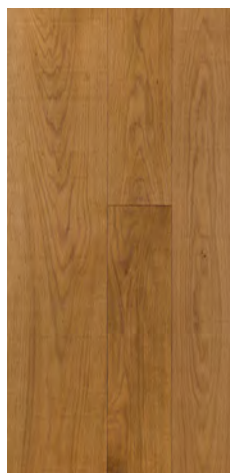

SUGHERO
ANTICO



TABACCO

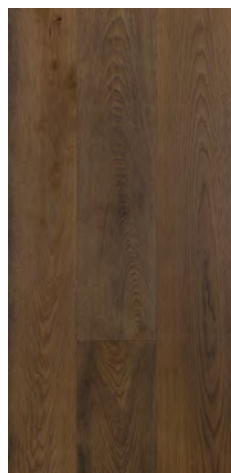

TERRA

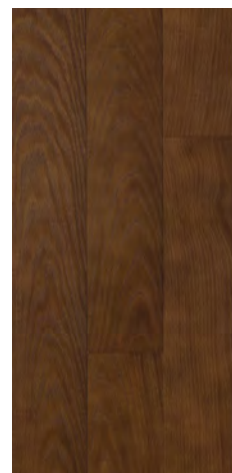

VECCHIO
CASALE



EMOTIONS & COLOURS



PICASSO SPAZZOLATO / BRUSHED

Spazzolato / *Brushed*

1

Lavorazioni
Surface finishes

11
Colorazioni
Colors

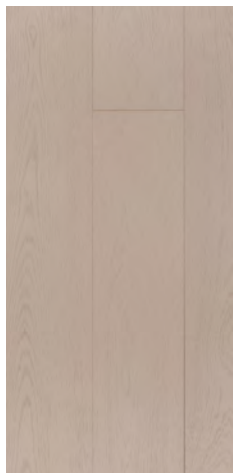

BOTTICELLI

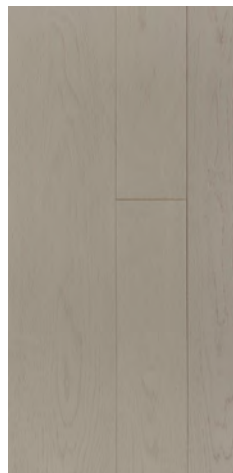

CARAVAGGIO



GIOTTO



KANDINSKY



MICHELANGELO

MONET



MIRÒ

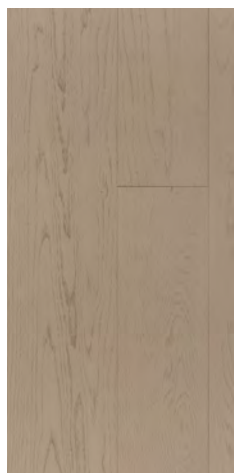

PICASSO

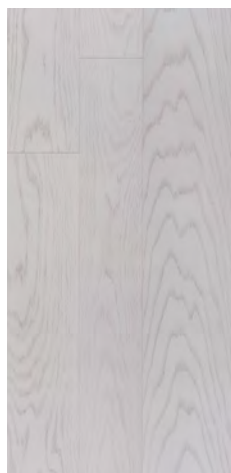

REMBRANDT



VELASQUEZ

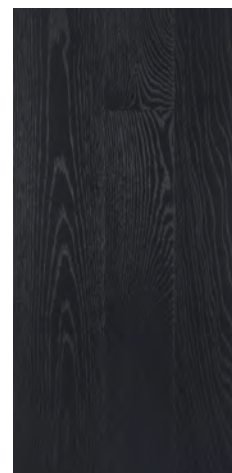

WARHOL



HARMONY & NATURE

Prodotto oliato / Oil treatment



IVORY SPAZZOLATO / BRUSHED

10
Lavorazioni
Surface finishes

Piallato a mano / *Hand Planed*

Spazzolato / *Brushed*

Stonato e Piallato a Mano / *Rounded Hand Planed*

Piallato Anticato / *Hand Planed Antiqued*

Scolpito a Mano / *Hand Sculptured*

Segato / *Sawn*

Sabbiato / *Sandblasted*

Stonato Sabbiato / *Rounded Sandblasted*

Piallato Morbido Sabbiato / *Soft Hand Planed Sandblasted*

Segato Sabbiato / *Sawn Sandblasted*

11
Colorazioni
Colors



AMBER



BALANCE



CALMNESS



CHOCCOLATE

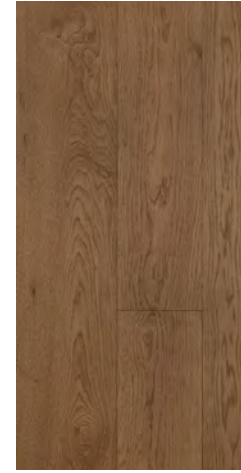

CINNAMON

DELIGHT



EMOTION

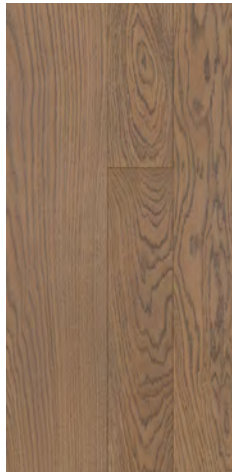

IVORY

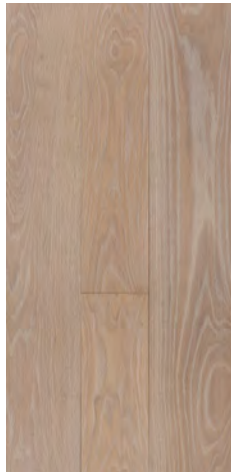

JOY

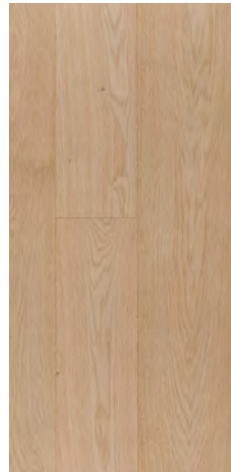

PASSION



VANILLA





QUERZIA ARGENTATA PIALATO MORBIDO SABBIAIO / SOFT HAND PLANED SANDBLASTED

9 Lavorazioni Surface finishes

Spazzolato / *Brushed*

Segato / *Sawn*

Pialato a Mano / *Hand Planed*

Pialato Anticato / *Hand Planed Antiqued*

Scolpito a Mano / *Hand Sculptured*

Stonato Sabbiaio / *Rounded Sandblasted*

Pialato Morbido Sabbiaio / *Soft Hand Planed Sandblasted*

Segato Sabbiaio / *Sawn Sandblasted*

Sabbiaio / *Sandblasted*

11
Colorazioni
Colors

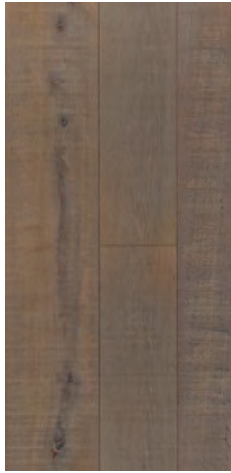

QUERCIA
ACQUAMARINA



QUERCIA
ARGENTATA

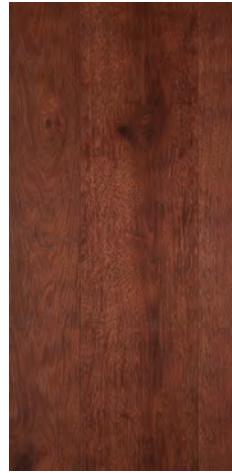

QUERCIA
BRONZO

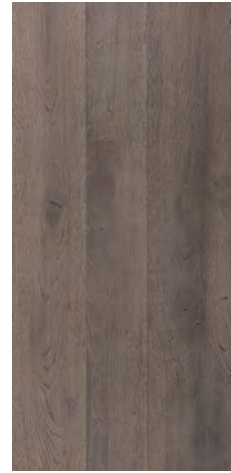

QUERCIA
CORALLO



QUERCIA
DIAMANTE

QUERCIA
DORATA

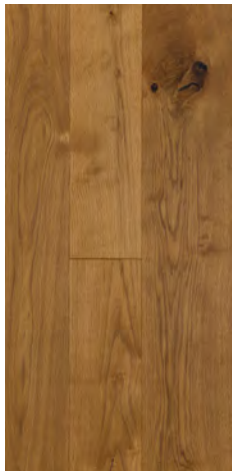

QUERCIA
GIADA



QUERCIA
OPALE

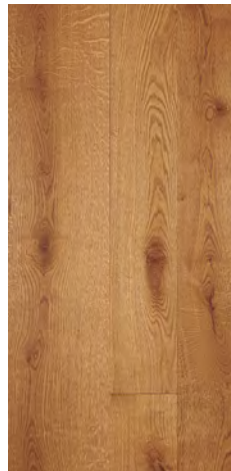

QUERCIA
PLATINO



QUERCIA
SMERALDO



QUERCIA
TURCHESE



NATURAL WOOD



NOCE AMERICANO PRELEVIGATO / PRE-SMOOTHED

12 Lavorazioni Surface finishes

Prelevigato / Pre-smoothed

Spazzolato / Brushed

Piallato a Mano / Hand Planed

Stondato Piallato a Mano / Rounded Hand Planed

Piallato Anticato / Hand Planed Antiqued

Scolpito a Mano / Hand Sculptured

Consumato / Aged

Sabbiato / Sandblasted

Stondato Sabbiato / Rounded Sandblasted

Piallato Morbido Sabbiato / Soft Hand Planed Sandblasted

Segato Sabbiato / Sawn Sandblasted

Segato / Sawn

6

Colorazioni
Colors

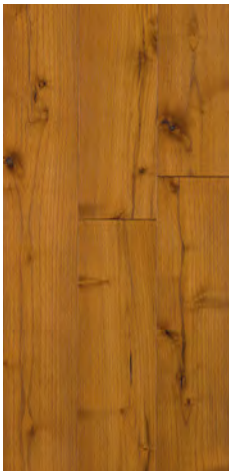

ACACIA

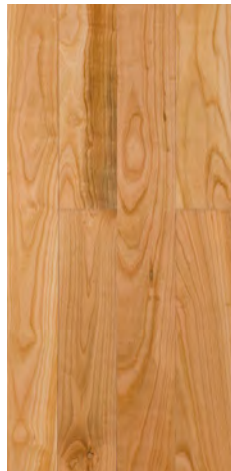

CILIEGIO
EUROPEO



NOCE
AMERICANO

NOCE
EUROPEO

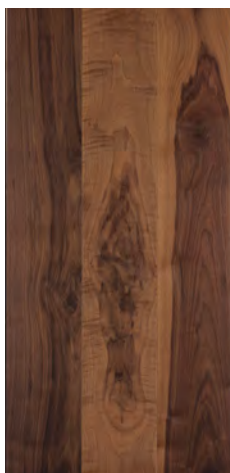

OLMO
EUROPEO

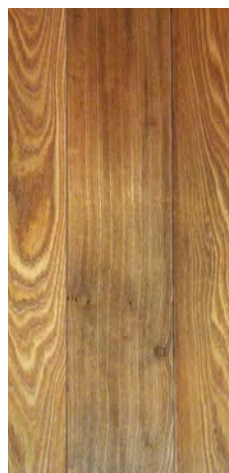

ROVERE

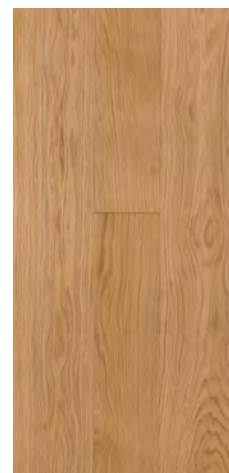

BARRICATI



BAROLO SCOLPITO A MANO / HAND SCULPTURED

5
Lavorazioni
Surface finishes

Spazzolato / *Brushed*

Piallato a Mano / *Hand Planed*

Piallato Anticato / *Hand Planed Antiqued*

Scolpito a Mano / *Hand Sculptured*

Sabbiato / *Sandblasted*

6
Colorazioni
Colors

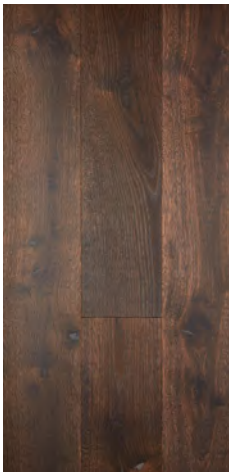

AMARONE



BAROLO

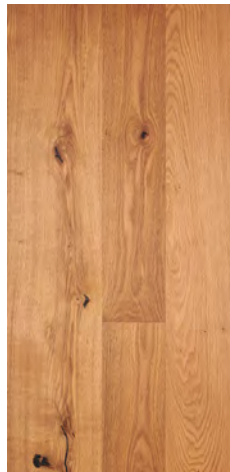

BRUNELLO

CHIANTI

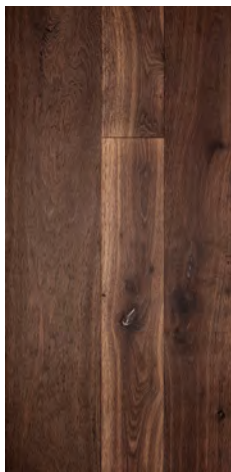

DOLCETTO

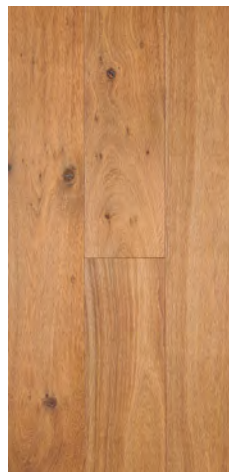

NEBBIOLO

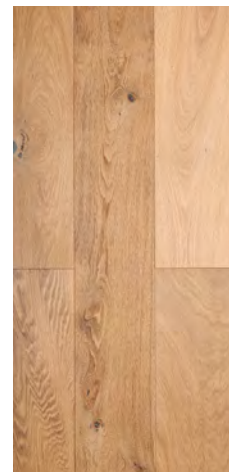

LOIRE CASTLES



GREY CASTLE SEGATO / SAWN

5

Lavorazioni
Surface finishes

Sabbiato / Sandblasted

Stondato Sabbiato / Rounded Sandblasted

Piallato Morbido Sabbiato / Soft Hand Planed Sandblasted

Segato Sabbiato / Sawn Sandblasted

Segato / Sawn

2 Colorazioni Colors

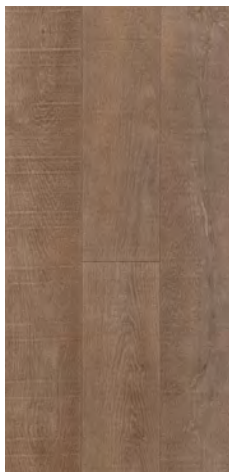

GREY CASTLE



RUSSIAN COFFEE

“Russian Coffee” e “Grey Castle” sono le due nuance esclusive del progetto “Loire Castles”. Nel loro processo di realizzazione, vengono utilizzati dei reagenti naturali, che interagiscono con un elemento già presente negli alberi: il tannino.

La reazione di questa sostanza, presente nel legno in quantità diverse a seconda dell’esposizione e della crescita di ciascun albero, determina le variazioni di colore e la ricchezza cromatica delle superfici “Loire Castles”: variabili, ricche e irripetibili, com’è la natura.

Il colore del pavimento potrà considerarsi definitivo solo dopo alcuni mesi di “maturazione”.

“Russian Coffee” and “Grey Castle” are the two nuances exclusive to the “Loire Castles” project. Their production process calls for the use of natural reactants that interact with an element already present in trees: tannin.

The reaction of this substance, the quantity of which differs depending on the exposure and growth of each tree, determines the variations in colour and chromatic richness of the “Loire Castles” surfaces: variable, rich, and unrepeatable, like Nature.

The colour of the floor can only be considered definitive after a few months of “maturation”.

ANTICHI SAPORI

Prodotto oliato / Oil treatment



ROVERE OLD SPAZZOLATO / BRUSHED

4
Lavorazioni
Surface finishes

Prelevigato / *Pre-smoothed*
Spazzolato / *Brushed*
Piallato a Mano / *Hand Planed*
Sabbiato / *Sandblasted*

4
Colorazioni
Colors



OLMO OLD

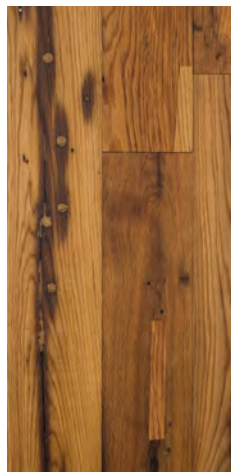

ROVERE OLD



OLMO OLD
ACCIAIO



ROVERE OLD
ACCIAIO

PALATINO



BROCCATO SCAVATO / ENGRAVED

Scavato / Engraved

1
Lavorazioni
Surface finishes

5
Colorazioni
Colors

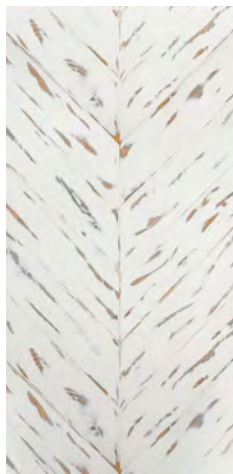

ANGORA



BROCCATO

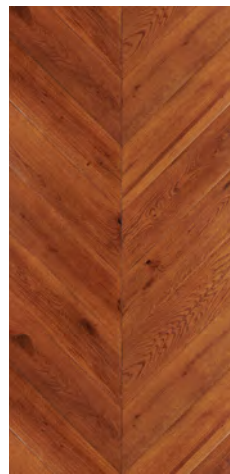

ORGANZA

RASO



VELLUTO



SOUNDS OF DANUBIO

Prodotto oliato / Oil treatment



6 Lavorazioni Surface finishes

- Spazzolato / *Brushed*
- Segato / *Sawn*
- Piallato a Mano / *Hand Planed*
- Stondato Piallato a Mano / *Rounded Hand Planed*
- Piallato Anticato / *Hand Planed Antiqued*
- Scolpito a Mano / *Hand Sculptured*

11
Colorazioni
Colors

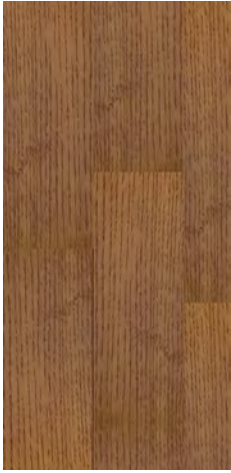

BREZZA

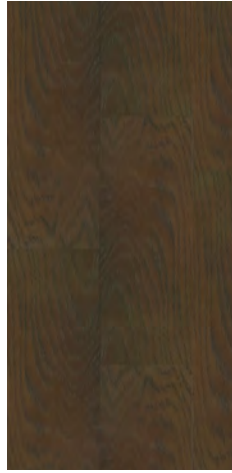

ECO



FREMITO

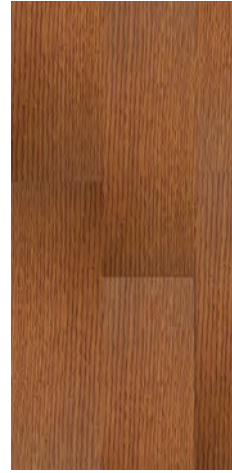

FRUSCIO

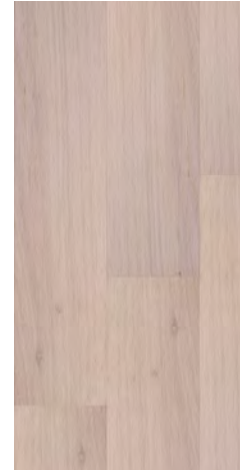

RESPIRO

RUGIADA



SILENZIO

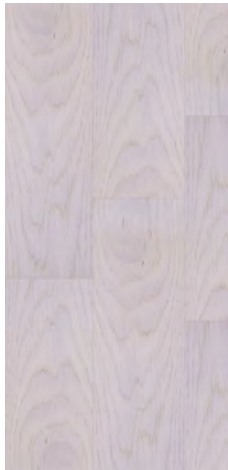

SOFFIO

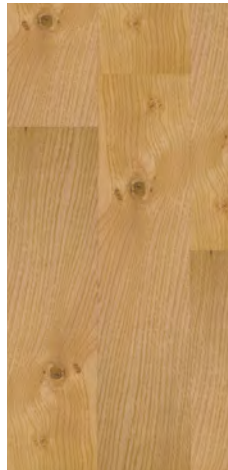

SUSSURRO

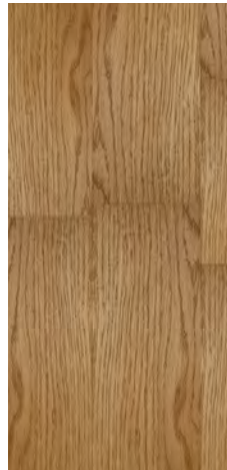

TEPORE

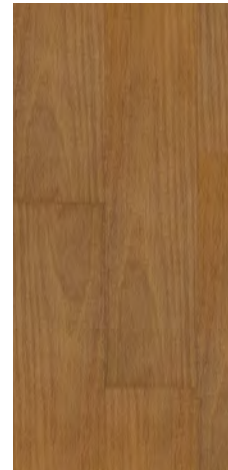

TUONO





WOODETTE



Tutte le
colorazioni
RAL

Entire
RAL palette

WOODETTE

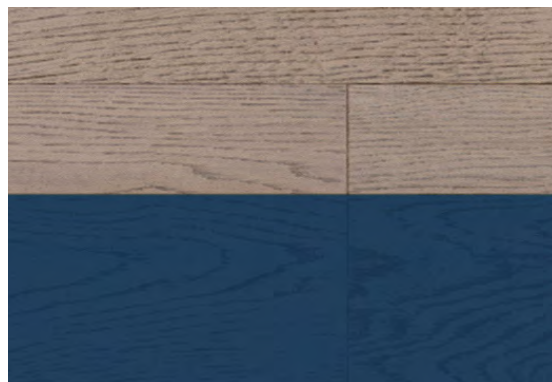
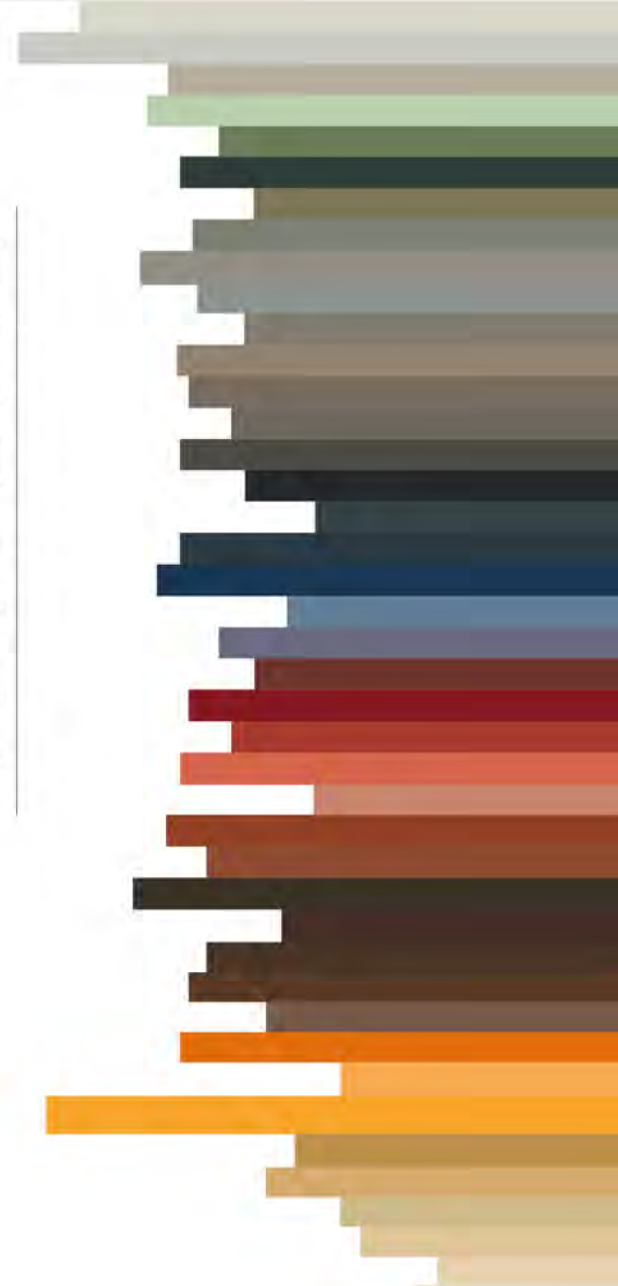

1
Lavorazioni
Surface finishes



Forme

Realizziamo geometrie esclusive e composizioni ricercate, su pavimenti e pareti. Ogni elemento viene combinato e accostato, in modo da valorizzarne materia, colore e lavorazione di superficie, con un risultato d'insieme unico e d'autore.

Shapes

We create exclusive geometries and sophisticated compositions on floor and walls. Each element is combined and arranged so as to enhance the material, colour, and surface finish with a totally unique design result.

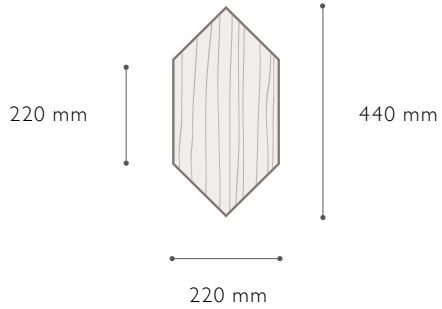
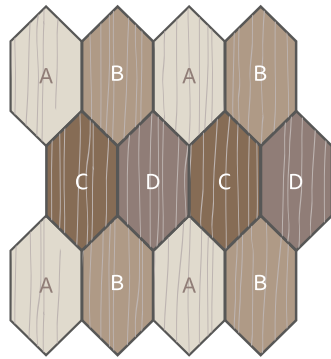
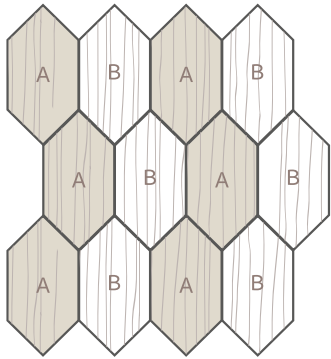

Damasco



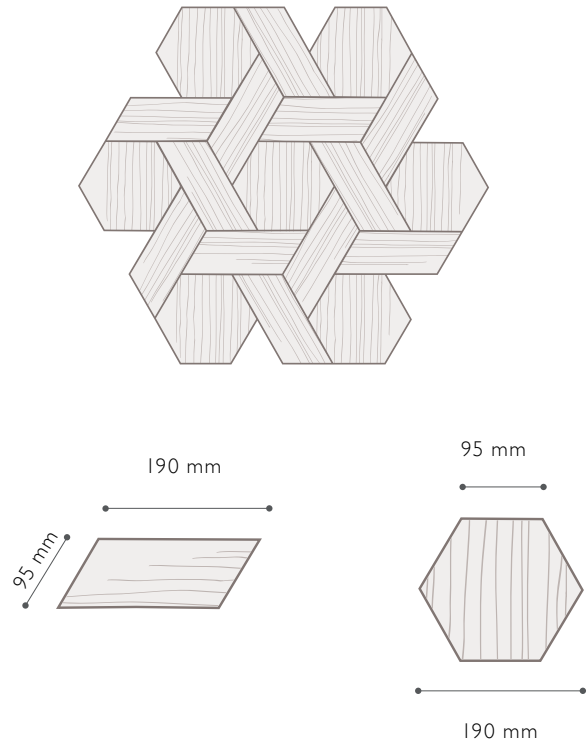

Casablanca

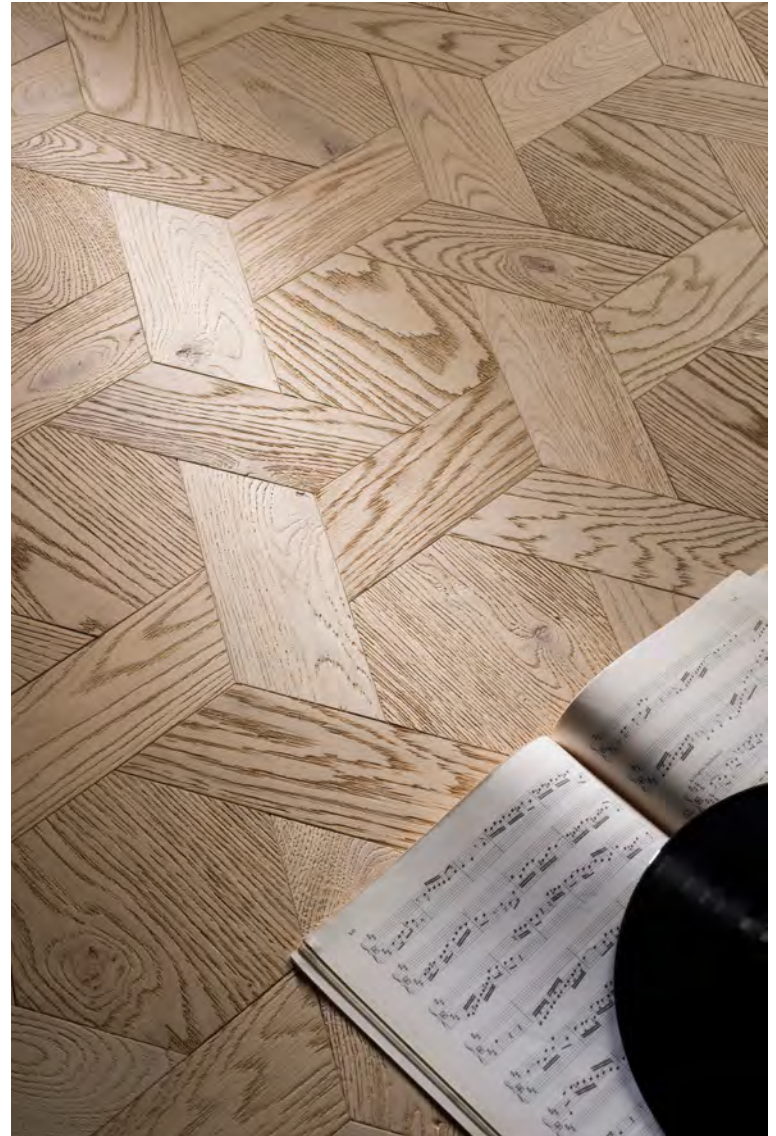



MIRAMARE
1105x1105 mm
(Fornita non montata)
Prelevigato
Spazzolato
Piallato a Mano
Sabbiato
Scolpito a Mano

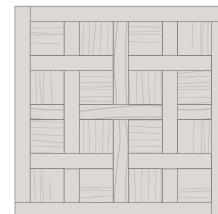

VISCONTI
1000x1000 mm
Prelevigato
Spazzolato
Piallato a Mano
Stondato Piallato a Mano
Consumato
Sabbiato
Stondato Sabbiato
Scolpito a Mano

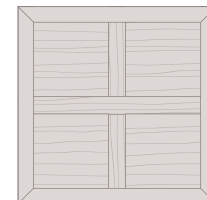

GRADARA
900x900 mm
Prelevigato
Spazzolato
Piallato a Mano
Sabbiato
Scolpito a Mano

Quadrotte

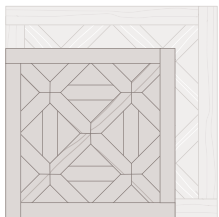

CAVALLARI
800x800 mm
1000x1000 mm
Prelevigato
Spazzolato
Piallato a Mano
Sabbiato
Scolpito a Mano

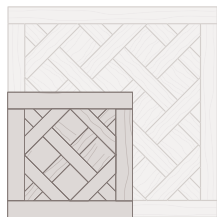

BRINDISI
600x600 mm
1000x1000 mm
Prelevigato
Spazzolato
Piallato a Mano
Consumato
Sabbiato
Scolpito a Mano

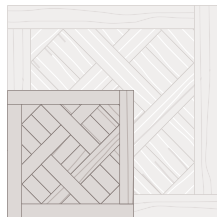

MAROSTICA
600x600 mm
1000x1000 mm
Prelevigato
Spazzolato
Piallato a Mano
Sabbiato
Scolpito a Mano

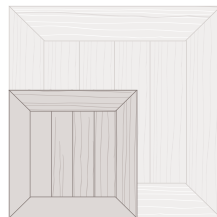

ZUMELLE
600x600 mm
1000x1000 mm
Prelevigato
Spazzolato
Piallato a Mano
Consumato
Sabbiato
Scolpito a Mano

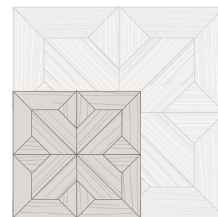

MASINO
600x600 mm
1000x1000 mm
Prelevigato
Spazzolato
Piallato a Mano
Consumato
Sabbiato
Scolpito a Mano



VINCI
600x600 mm
1000x1000 mm
Prelevigato
Spazzolato
Piallato a Mano
Consumato
Sabbiato
Scolpito a Mano



OLIVETO
600x600 mm
Prelevigato
Spazzolato
Piallato a Mano
Consumato
Sabbiato
Scolpito a Mano



LUCCHIO
600x600 mm
Prelevigato
Spazzolato
Piallato a Mano
Consumato
Sabbiato
Scolpito a Mano



VERRONE
600x600 mm
Prelevigato
Spazzolato
Piallato a Mano
Sabbiato
Scolpito a Mano



PISANI
595x595 mm
Prelevigato
Spazzolato
Piallato a Mano
Sabbiato
Scolpito a Mano



BEVILACQUA
475x475 mm
Prelevigato
Spazzolato
Piallato a Mano
Sabbiato
Scolpito a Mano

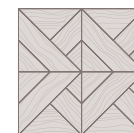

VERAZZANO
400x400 mm
Prelevigato
Spazzolato
Piallato a Mano
Sabbiato
Scolpito a Mano

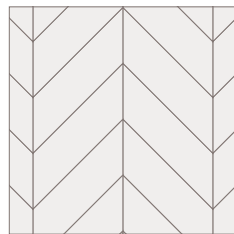

SPINA UNGHERESE
45 gradi
LA / W : 180 mm
LU / L : 760 mm

Disponibile
in 3 e 2 strati

3 strati 20 mm disponibile
per la collezione Palatino

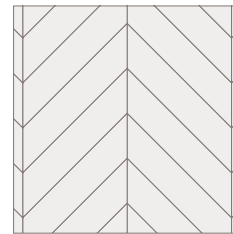

SPINA UNGHERESE
45 gradi
LA / W : 140 mm
LU / L : 790 mm

Disponibile
in 3 e 2 strati

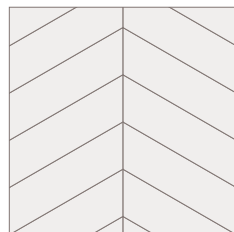

SPINA UNGHERESE
30 gradi
LA / W : 180 mm
LU / L : 820 mm

Disponibile
in 3 e 2 strati

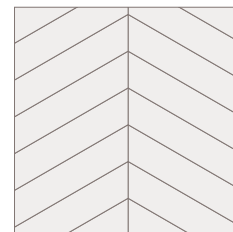

SPINA UNGHERESE
30 gradi
LA / W : 140 mm
LU / L : 840 mm

Disponibile
in 3 e 2 strati

Spine

Herringbones

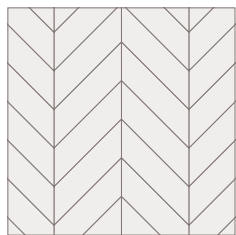

SPINA UNGHERESE
45 gradi
LA / W : 120 mm
LU / L : 540 mm

Disponibile
in 3 e 2 strati

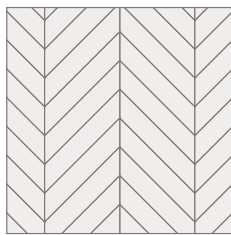

SPINA UNGHERESE
45 gradi
LA / W : 90 mm
LU / L : 560 mm

Disponibile
in 3 e 2 strati

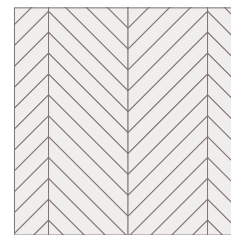

SPINA UNGHERESE
45 gradi
LA / W : 65 mm
LU / L : 560 mm

Disponibile
in 3 e 2 strati

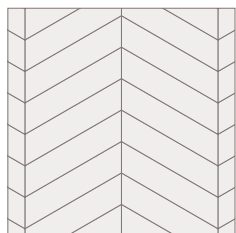

SPINA UNGHERESE
30 gradi
LA / W : 120 mm
LU / L : 560 mm

Disponibile
in 3 e 2 strati

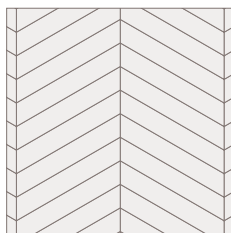

SPINA UNGHERESE
30 gradi
LA / W : 90 mm
LU / L : 580 mm

Disponibile
in 3 e 2 strati

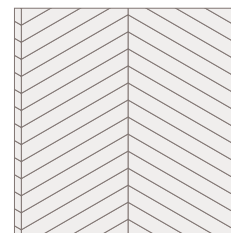

SPINA UNGHERESE
30 gradi
LA / W : 65 mm
LU / L : 580 mm

Disponibile
in 3 e 2 strati

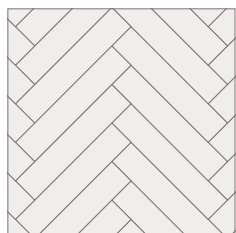

SPINA ITALIANA
90 gradi
LA / W : 120 mm
LU / L : 600 mm

Disponibile
in 3 e 2 strati

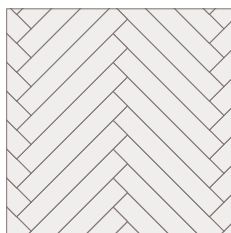

SPINA ITALIANA
90 gradi
LA / W : 90 mm
LU / L : 600 mm

Disponibile
in 3 e 2 strati

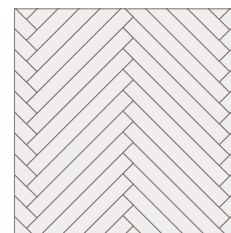

SPINA ITALIANA
90 gradi
LA / W : 65 mm
LU / L : 600 mm

Disponibile
in 3 e 2 strati



Tavole

Riserva 1885

Tavole di dimensioni importanti, realizzate a partire da alberi scelti, nati più di 130 anni fa. Per più di un secolo hanno assorbito lo splendore e la storia del mondo, bellezza e segni che oggi mettono a nudo una superficie ricca, autentica, tutta da mostrare.

Boards of considerable dimensions made with selected trees planted more than 130 years ago. For more than a century they have absorbed the splendour and the history of the world, beauty and traces of the past alike, that today are revealed through a surface that is rich and authentic, to be admired.

Wall:Design



Be:Wall

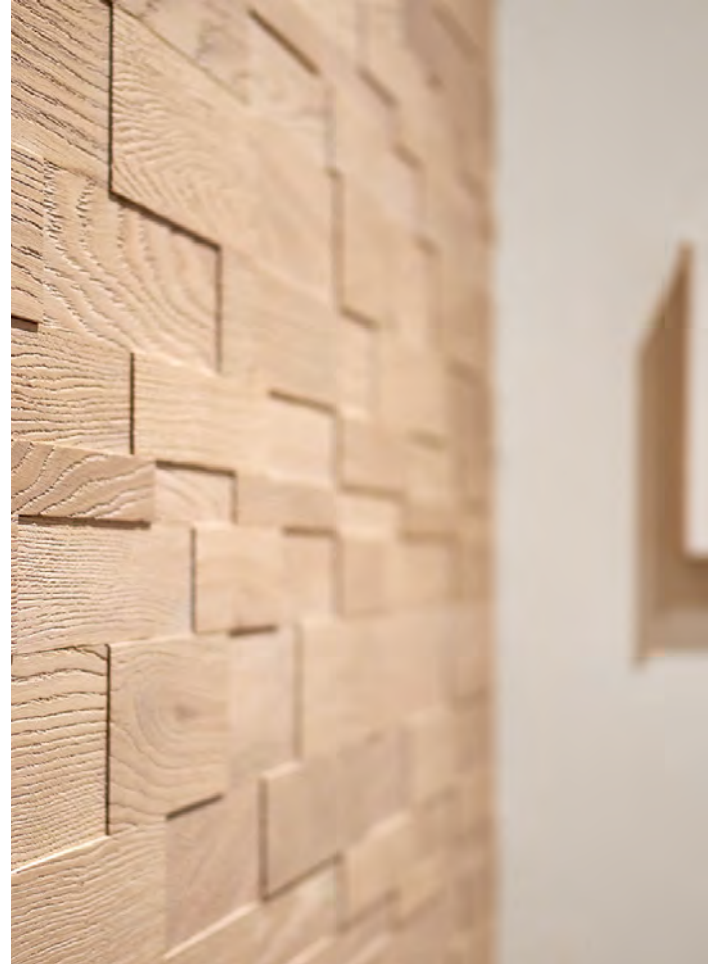

Scale

Se vuoi creare continuità tra i pavimenti e gli accessori della tua casa, scegli di rivestire la tua scala in legno. Hai a tua disposizione le essenze rovere, noce e acacia e una serie di accessori realizzati artigianalmente.

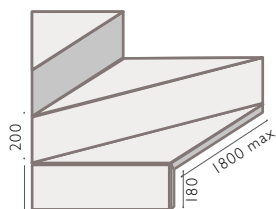

PIEDE D'OCA

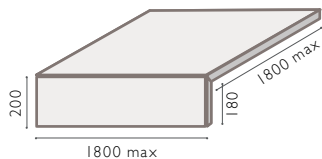

PIANEROTTOLO

Stairs

To create a combination between the floor and the rest of the house you can choose to complete also your stair steps in wood. Here are all the wood essences at your disposal: oak, walnut, acacia and all handmade accessories.

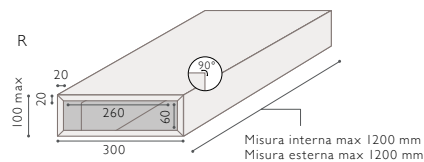

SCATOLA GRADINO

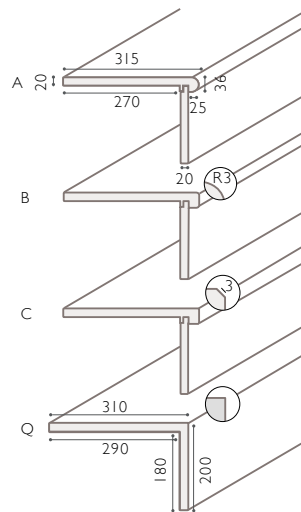

GRADINO BASE

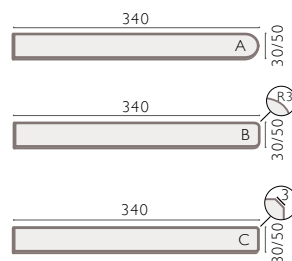

BORDATURA LATERALE PEDATA SP 5,2 MM

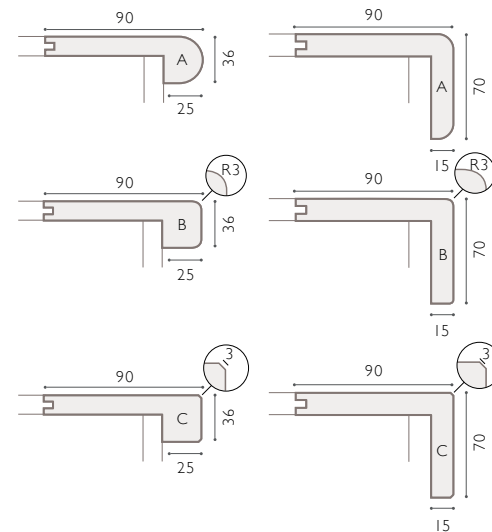

FASCIA CON TORO

FASCIA CON ALZATA

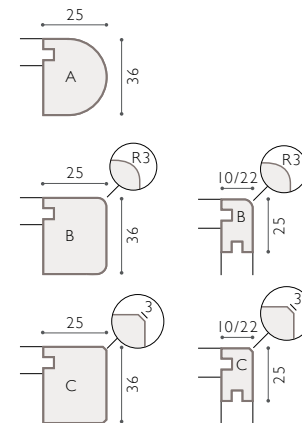

TORO

ANGOLARE

Profili

I nostri profili ti danno la possibilità di completare il pavimento, dando continuità ai colori e all'atmosfera della tua casa.

Profiles

Our matching profiles give you the possibility to complete the floor installed simply maintaining the same color style and coordinate all the habitat around you.

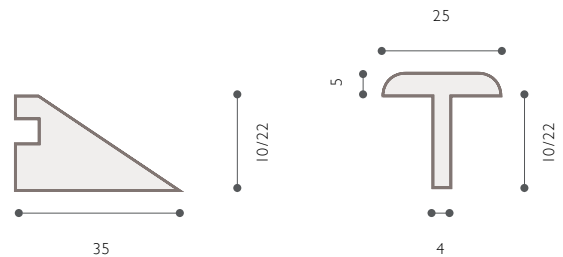

RACCORDO E GIUNTO DI DILATAZIONE

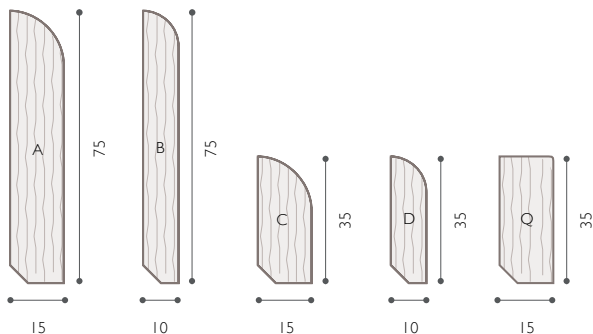

BATTISCOPIA MASSICCIO

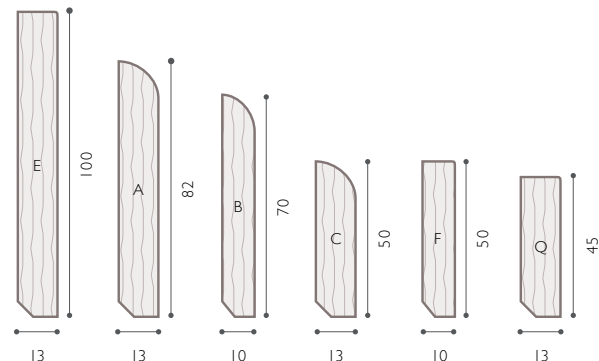

BATTISCOPIA IMPIALLACCIATO



mardeganlegno.com

SEDE COMMERCIALE

Mardegan Legno Srl - Via Spada, 5 - 31050 Fanzolo di Vedelago (TV) - ITALY - Tel. +39 0423 467939 - italia@mardeganlegno.com

SHOWROOM

Via Olmetto, 1 - 20123 Milano (MI) - ITALY - Tel. +39 02 30069188 - milano-showroom@mardeganlegno.com